

SAMSUNG

OWNER'S INSTRUCTIONS

ENGLISH

SR-058 / SR-118

SAMSUNG

REFRIGERATOR

Before operating the unit, please read this manual thoroughly, and retain for future reference.

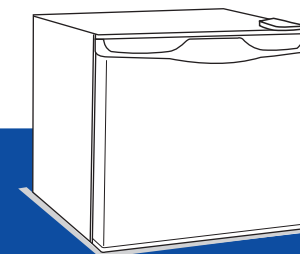

EN.....ENGLISH

SAFETY PRECAUTIONS

Read Instructions

EN:All the safety and operating instructions should be read before the appliance is operated.

Retain Instructions

EN:The safety and operating instructions should be retained for future reference.

Heed Warnings

EN:All warnings on the appliance and in the operating instructions should be adhered to.

Follow Instructions

EN: All operating and use instructions should be followed

Model and serial numbers

EN:Please refer to both model and serial numbers in any correspondence concerning your freezer/refrigerator.

Data of Purchased:.....
Model No:.....
Serial No

CONTENTS/INDICE

SAFETY PRECAUTIONS.....	1
SAFETY INSTRUCTIONS.....	2
NAME OF REFRIGERATOR AND OPERATION.....	4
TEMPERATURE CONTROL.....	6
TO MAKE ICE CUBES.....	7
DEFROSTING.....	8
STORAGE AND CLEANING.....	9
TROUBLESHOOTING	11

SAFETY INSTRUCTIONS

INSTALLATION

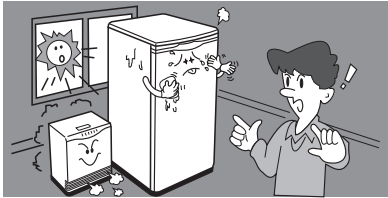

EN:

Keep regular intervals

- Leave a space of 50mm between refrigerator back and wall behind. If your refrigerator is going into a recessed area in the wall, allow at least 10inches or more clearance above the refrigerator.

This refrigerator is designed for free standing only.

- This refrigerator should not be recessed or built in.

Avoid the direct sunlight or heater

- As plastic and electrical components are affected by direct heat, never place the unit near cookers, radiators or in places exposed to direct sunlight.
- Normal room temperature is recommended.

Never install the unit near water.

- Avoid locations which may be affected by delete or dampness as this will impair the efficiency of the insulation.

Install on a stable, level surface.

- Make sure it is placed on a flat, level surface .

For personal safety, this appliance must be properly grounded.

- This refrigerator should not be grounded with telephone line,gas pipe,etc.

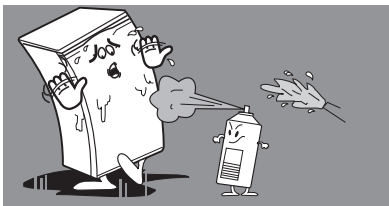

CAUTIONS WHILE USING**EN:**

Do not use the appliance if it is not operating correctly or has been damaged. Disconnect it from the power supply and call your local service center.

Be careful not to splash water on the back of the refrigerator.

-The insulation of the electric parts will be impaired by water.

Avoid leaving the door open any longer than necessary as this will impair the efficiency of the unit making it more costly to run.

Do not use flammable sprays such as lacquer and paint near the refrigerator, because there is a possible danger of ignition.

Do not put volatile chemicals such as ether and benzene in the refrigerator, because there is a danger of explosion.

Don't allow children to hang on the door.

-Children should not be left alone or unattended in an area where the appliance is in use. They may be hurt and could damage the refrigerator.

If the power is damaged, avoid a hazard by replacing it through the manufacturer or its service agent or a similarly qualified person.



Don't use the appliance outdoors or let it be rained on.

COMING EVENTS**EN:**

When out of operated for a long time .

- Remove all food and disconnect the power supply cord. Dry your refrigerator, opening the door for 2-3days.

When you get ready to move

- Securely fasten removable interior part (or remove and package them separately).

- Do not place your refrigerator horizontally, or compressor may be damaged.

Power failure

- You should keep the door closed, while the power is off (1-2 hours).

- During power failure of longer periods take steps to protect your frozen food by placing block of dry-ice on top of packages if

- If dry-ice is not available see if you can temporarily use a freezer in your local locker plant if

PARTS AND OPERATION

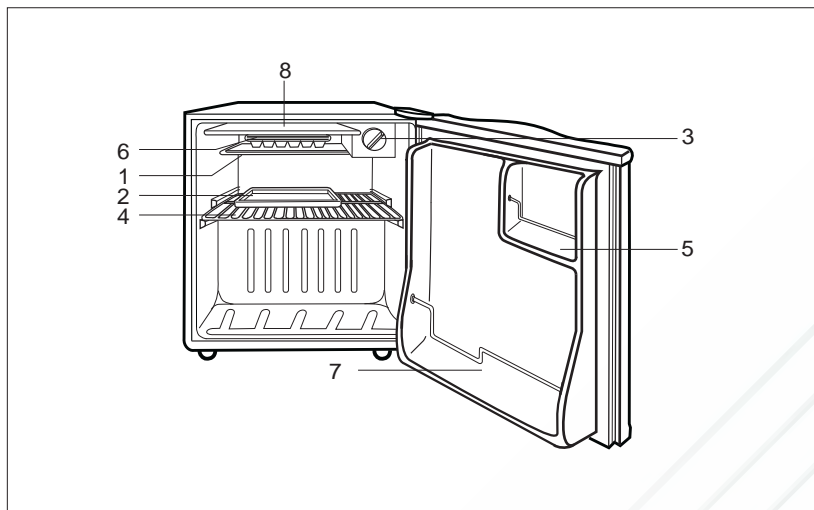

FRONT OF THE REFRIGERATOR



EN:

1. Freezing Compartment
Use for making ice cubes and for storage of frozen foods and ice cream.
But not suitable for long term storage of frozen foods.
2. Drip Tray
Catches melted water on defrosting.
3. Cold Control Knob
Rotate this to adjust refrigerator temperature and to defrost.
4. Slide Out Shelf
Odor resistant, rustproof plastic coated steel shelf.
5. Guard Rack, A
6. Guard Rack, B
7. Guard Rack, C
8. Freezer Cover

TROUBLESHOOTING

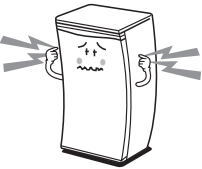
SYMPTOMS	CHECKS
<p>EN: Refrigerator does not operate</p> 	<p>EN:</p> <ul style="list-style-type: none"> - Check if there is electrical power to equipment - Check if the home's main circuit breakerbox is working . - The refrigerator control dial "on".
<p>EN: Refrigerator is warmer than usual</p> 	<p>En:</p> <ul style="list-style-type: none"> - Check if control is set properly. - Check if the door has been open for a long time. - Have you recently added a large quantity of food?
<p>EN: There are unusual noises</p> 	<p>EN:</p> <ul style="list-style-type: none"> - Check if the unit is installed in a firm place or not. - Is shelving or storage loose inside the unit? - Is evaporating tray inserted properly?

PREPARATIONS FOR USE

EN: All of the following should be satisfied when tested in the following order. If not check electricity supply. When cause of trouble can not be located contact your dealer.

EN:

1. Place all shelves, all kinds of vessels in their proper positions which have been removed for transportation.
2. Clean refrigerator and parts to remove dust incurred during shipping.
3. Set cold control knob at "COLD" position and let refrigerator operate for one hour. Freezer compartment should get slightly chilled and motor should run smoothly with no noise but soft hum.
4. Store food after the temperature in the refrigerator gets sufficiently low. It takes a few hours after starting the refrigerator to reach the proper temperature.
5. Your refrigerator is operated by a compressor which switches "on and off" to maintain the internal temperature. When the compressor is new it requires running in for a period of up to 2 months. During this period it may operate a little noisier than normal. This is quite normal and does not represent a fault.

CLEANING THE REFRIGERATOR

HOW TO CLEAN THE UNIT

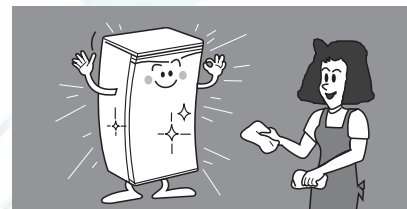

EN:

Exterior

- Wipe with a damp sudsy cloth, then dry.
- For stubborn stains and for periodic waxing, use silicon wax.

Interior

- Wash entire compartments with a baking soda solution (two table-spoon of baking soda to one quart of warm water). Rinse and dry.

Interior parts

- Wash compartment shelves, door shelves etc. With either the baking soda solution or a mild detergent and warm water. Rinse and dry.

Magnetic door gaskets

- Wash with warm sudsy water, rinse thoroughly and dry.

The drained water evaporating tray

- To take out the drained water tray placing under evaporator lift upward slightly and put it being likely slide out downward slant. Clean it once in a month.
- It is not inserted properly, drained water is full of tray and it cannot be vaporized or it will cause unusual vibrating noises.

The finishing touch



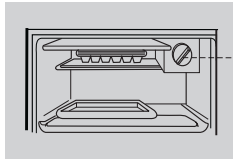

- Insert all parts to proper location and set "Temperature control" to desired setting.

TEMPERATURE CONTROL



TEMPERATURE CONTROL

EN: To adjust the refrigerator's temperature, adjust the temperature control dial.
Do not set the refrigerator temperature lower than necessary.
After operation as continuous operation, be sure to adjust the thermostat to original position.

TEMPERATURE CONTROL	SITUATION
<p>Winter</p> 	<p>EN: The nearer to "1" the dial setting, the warmer it will become.When small quantity of foods are stored.</p>
<p>Normal</p> 	<p>EN: To maintain the optimum inside condition food storage condition set the control dial at "4" positionFor normal use.</p>
<p>Summer</p> 	<p>EN: The nearer to "MAX" the dial setting, the colder it will become.When large quantity of foods are stored.For quick ice-marking, set the dial at "MAX" position.</p>
<p>OFF or DEF</p> 	<p>EN: Set the dial at "DEF" or "OFF" position with the door opened.After about 40 minutes, the frost on the surface of the evaporator will begin to melt and can be easily removed.</p>

STORAGE AND CLEANING

TO STORE FOOD EFFICIENTLY



EN:

- Do not load your refrigerator or freezer with hot food. Allow sufficient time for cooling.
- It saves energy consumption and for freezing time.
- Be sure not to store bottles such as beer, cokes, etc. in the freezer compartment.
- Do not overload your set with a lot of foods.
- This refrigerator is not suitable for storing scientific items or medicines.

The procedures for replacing the bulb:

1. Unplug and disconnect the power.
2. Open the door and remove the water tray.
3. Remove the burned out bulb by rotating it.
4. Replace it with a new bulb.
5. Put the water tray back and plug the power.

TO MAKE ICE CUBES

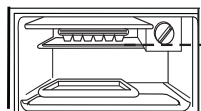

— FREEZER COMPARTMENT

EN: If you want to make ice cubes put the ice tray in the freezer compartment.

EN: Fill water into the ice tray to the about 80%capacity.

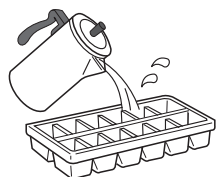

EN: Slide the ice tray into the freezer compartment.

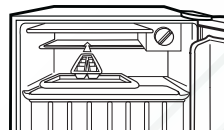

EN: When you want to make ice cubes rapidly, the thermostat should be set at "MAX".

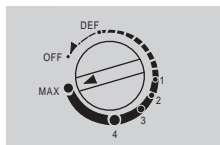

EN: Hold both ends of the ice tray, remove the ice cubes from the tray by twisting it gently. Do not bend the ice tray or it will crack.



DEFROSTING

HOW TO DEFROST

1 Empty freezer.

EN: Remove ice tray and frozen foods to the fresh food compartment.

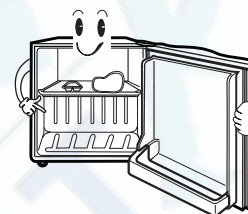

2 Set the temperature control to "OFF".

EN: With the freezer door opened, set the temperature control to "OFF". In 30 to 40 minutes, the frost on the freezer wall will begin to melt and can be easily removed.

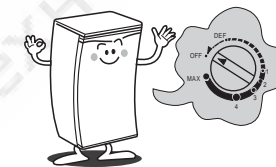

3 Remove the frost with a soft cloth only.

EN: Remove the frost with a cloth and wipe the freezer bottom.

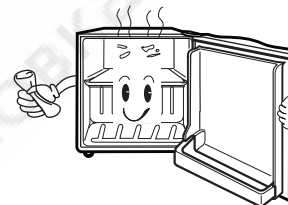

4 Do not use sharp objects.

EN: If the frost is forced off with a knife or a screwdriver, the surface of the freezer will be damaged or have a hole made in it. From the hole, refrigerator would leak and result in inability to refrigerate.

